

# LINHA TRILHA

The image features three white plastic chairs with a speckled pattern of black, blue, and yellow particles. The chairs are arranged in a row, with the middle one being the most prominent. They have a simple metal frame. The background is plain white.

novidário

# Linha Trilha

- 4. banco coletivo
- 6. mesa coletiva
- 8. mesa restaurante
- 9. mesa piquenique 4 lugares
- 10. mesa piquenique 2 lugares
- 12. poltrona
- 14. mesa lateral
- 16. acabamentos

Linha de mobiliário coletivo desenhada para áreas de convívio, com estruturas de alumínio e assentos e tampos de mesa produzidos em plástico reciclado de tipos variados. Composta por mesas piquenique, de dois e quatro lugares, bancos e mesas coletivas, mesa restaurante, poltrona e mesas laterais.







# Banco Coletivo Trilha



Estrutura em tubos de alumínio. Assento em placas produzidas a partir da reciclagem de plástico pós-uso. Consulte acabamentos disponíveis.

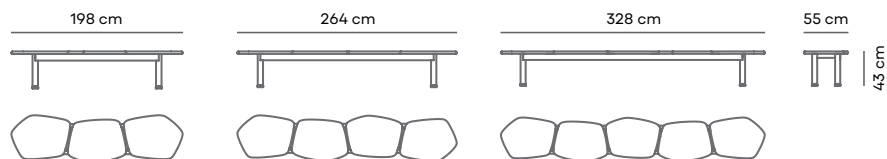



# Mesa Coletiva Trilha



Estrutura em tubos de alumínio. Tampo e base em placas produzidas a partir da reciclagem de plástico pós-uso. Consulte acabamentos disponíveis.

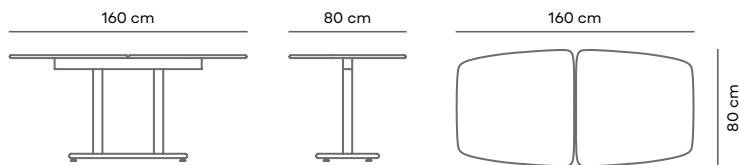





# Mesa Restaurante Trilha



Estrutura em tubos de alumínio. Tampo e base em placas produzidas a partir da reciclagem de plástico pós-uso. Consulte acabamentos disponíveis.

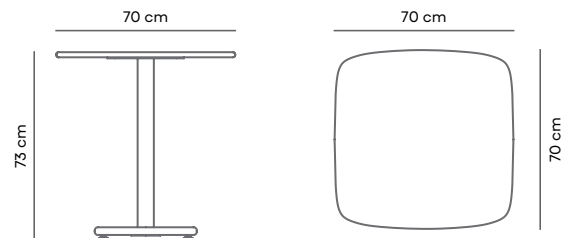



# Mesa Piquenique Trilha

## 4 lugares



Estrutura em tubos de alumínio. Assentos e tampos em placas produzidas a partir da reciclagem de plástico pós-uso. Consulte acabamentos disponíveis.

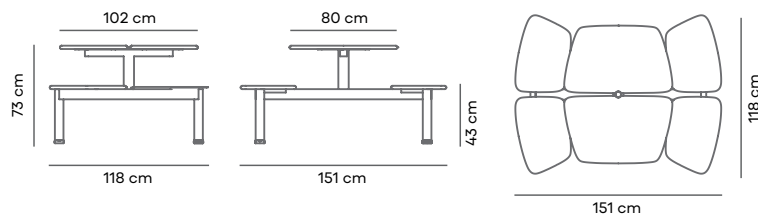

# Mesa Piquenique Trilha

## 2 lugares



Estrutura em tubos de alumínio. Assentos e tampo em placas produzidas a partir da reciclagem de plástico pós-uso. Consulte acabamentos disponíveis.

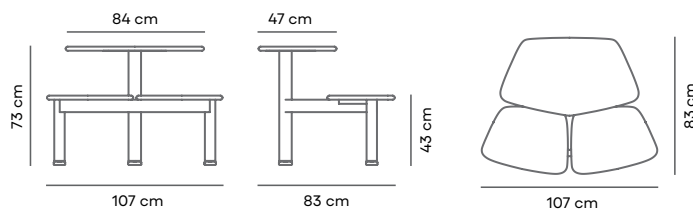



# Poltrona Trilha



Estrutura em tubos de alumínio. Assento, encosto e apoios de braço em placas produzidas a partir da reciclagem de plástico pós-uso. Consulte acabamentos disponíveis.

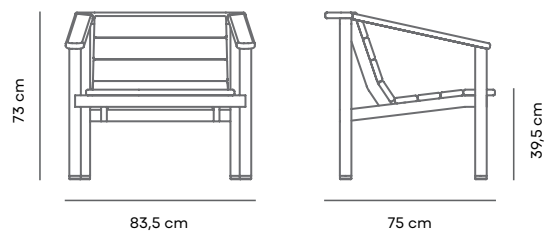





# Mesa Lateral Trilha



Estrutura em tubos e chapa de alumínio. Tampos em placas produzidas a partir da reciclagem de plástico pós-uso. Consulte acabamentos disponíveis.

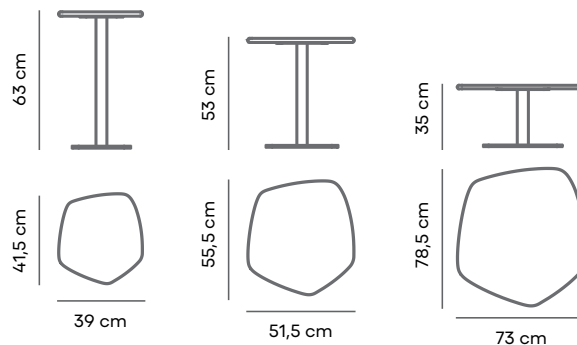





# Acabamentos

## Alumínio

---

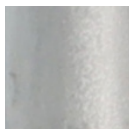

**\*Alumínio Vibrado**  
Lixamento manual uniforme da superfície do metal, facilitando o futuro processo de reciclagem da estrutura.

Alumínio Vibrado



Preto

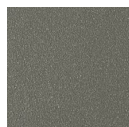

Grafite

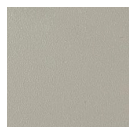

Cinza



Branco Fosco



Bege

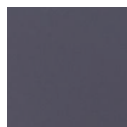

Roxo

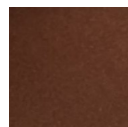

Corten

## Lynx (Plástico Reciclado)

---

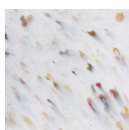

Constelações

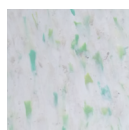

Limão

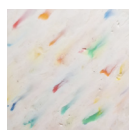

Primavera



Sanhaço



Dolomita

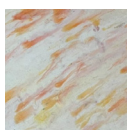

Seriguela

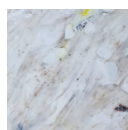

**Marfim**

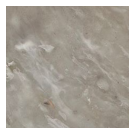

Gris



Baroque



Atlântico

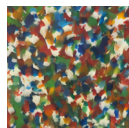

Croma



Nuit



# novidário

Rua Costa Carvalho, 113  
Pinheiros, São Paulo - SP  
05429-130

loja novidário:

 11 94484-2555

atendimento corporativo:

 11 97397-8087 | 11 3476-4488

 [contato@novidario.com.br](mailto:contato@novidario.com.br)

 [novidario.com.br](http://novidario.com.br)

Siga nossas redes:



[@novidario](#)



[@novidariooficial](#)